

## 3.6V-36V Vin, 3.5A, High Efficiency Synchronous Step-down DCDC Converter

### FEATURES

- AEC-Q100 Qualified with the Following Results:
  - Device Temperature Grade 1: -40°C to 125°C Ambient Operating Temperature Range
  - Device HBM ESD Classification Level H2
  - Device CDM ESD Classification Level C3B
- Wide Input Range: 3.6V-36V
- Up to 3.5A Continuous Output Current
- 1V  $\pm$ 1% Feedback Reference Voltage
- Integrated 60m $\Omega$  High-Side and 36m $\Omega$  Low-Side Power MOSFETs
- Pulse Skipping Mode (PSM) with 25uA Quiescent Current in Sleep Mode
- 60ns Minimum On-time
- 4ms Internal Soft-start Time
- 400kHz Switching Frequency
- Frequency Spread Spectrum (FSS) Modulation for EMI Reduction
- Precision Enable Threshold for adjustable Input Voltage Under-Voltage Lock Out Protection (UVLO) Threshold and Hysteresis
- Parallel input path to minimize switch node ringing
- Low Dropout Mode Operation
- Over-voltage and Over-Temperature Protection
- Available in 2mm\*3mm QFN-12L Package

### APPLICATIONS

- Automotive infotainment and ADAS
- USB Type-C Power Delivery, USB Charging
- Industrial and Medical Distributed Power Supplies

### DESCRIPTION

The SCT2434AQ is 3.5A synchronous buck converters with wide input voltage, ranging from 3.6V to 36V, which integrates a 60m $\Omega$  high-side MOSFET and a 36m $\Omega$  low-side MOSFET. The SCT2434AQ, adopting the peak current mode control, supports the Pulse Skipping Modulation (PSM) with typical 25uA low quiescent current which assists the converter on achieving high efficiency at light load or standby condition.

The SCT2434AQ features an internal 4ms soft-start time to avoid large inrush current and output voltage overshoot during startup. The switching frequency is fixed 400kHz. The SCT2434AQ allows power conversion from high input voltage to low output voltage with a minimum 60ns on-time of high-side MOSFET.

The SCT2434AQ is an Electromagnetic Interference (EMI) friendly buck converter with implementing optimized design for EMI reduction. The SCT2434AQ features Frequency Spread Spectrum FSS with  $\pm$ 6% jittering span of the 400kHz switching frequency and modulation rate 1/512 of switching frequency to reduce the conducted EMI.

The SCT2434AQ offers cycle-by-cycle current limit and hiccup over current protection, thermal shutdown protection, output over-voltage protection and input voltage under-voltage protection. The device is available in 2mm\*3mm QFN-12L package with wettable flanks.

### TYPICAL APPLICATION

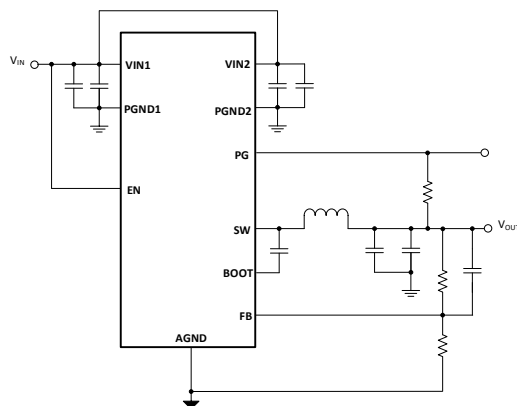

3.6V-36V, Synchronous Buck Converter

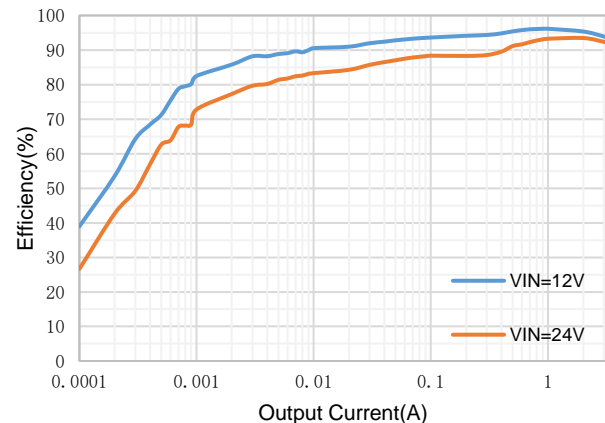

Efficiency,  $V_{OUT}=5V$ ,  $F_{SW}=400KHz$

# SCT2434AQ

## REVISION HISTORY

NOTE: Page numbers for previous revisions may differ from page numbers in the current version.

Revision 1.0: Release to production.

Revision 1.1: Update Pin Functions.

Revision 1.2: Update the selection of resistor R<sub>4</sub> in APPLICATION INFORMATION.

Revision 1.3: Update I<sub>LIM\_HS</sub>, PACKAGE INFORMATION and TAPE AND REEL INFORMATION.

Revision 1.4: Update DEVICE ORDER INFORMATION.

Revision 1.5: Update the limit of I<sub>LIM\_HS</sub> and I<sub>LIM\_LSSRC</sub>.

## DEVICE ORDER INFORMATION

ORDERABLE DEVICE	PACKAGING TYPE	STANDARD PACK QTY	PACKAGE MARKING	PINS	PACKAGE DESCRIPTION
SCT2434AQFPAR	Tape & Reel	5000	434AQ	12	FCQFN2x3-12

## ABSOLUTE MAXIMUM RATINGS

Over operating free-air temperature unless otherwise noted<sup>(1)</sup>

DESCRIPTION	MIN	MAX	UNIT
VIN	-0.3	42	V
EN	-0.3	42	V
BOOT	-0.3	48	V
SW	-1	42	V
BOOT-SW	-0.3	6	V
PG	-0.3	24	V
FB	-0.3	6	V
Operating junction temperature T <sub>J</sub> <sup>(3)</sup>	-40	150	°C
Storage temperature T <sub>STG</sub>	-65	150	°C

## PIN CONFIGURATION

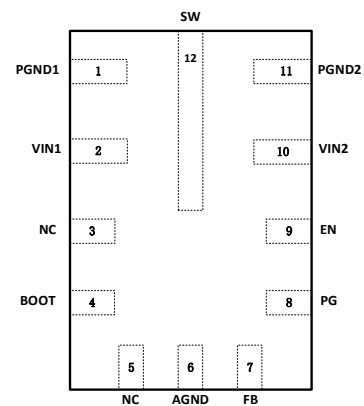

Figure 1. 12-Lead QFN 2mmx3mm

(1) Stresses beyond those listed under Absolute Maximum Rating may cause device permanent damage. The device is not guaranteed to function outside of its Recommended Operation Conditions.

(2) The max VIN transient voltage is guaranteed by design and verified on bench.

(3) The IC includes over temperature protection to protect the device during overload conditions. Junction temperature will exceed 150°C when over temperature protection is active. Continuous operation above the specified maximum operating junction temperature will reduce lifetime.

## PIN FUNCTIONS

NAME	NO.	PIN FUNCTION
PGND	1,11	Power ground to internal low side MOSFET. Connect to system ground. Low impedance connection should be provided to PGND2. Connect a high-quality bypass capacitor or capacitors from this pin to VIN1.
VIN	2,10	Input supply to the converter. Connect a high-quality bypass capacitor or capacitors from this pin to PGND1. Low impedance connection must be provided to VIN2.
NC	3	On the VQFN package, connect the SW pin to NC on the PCB. This simplifies the connection from the BOOT capacitor to the SW pin. This pin has no internal connection to the regulator.
BOOT	4	High-side driver upper supply rail. Connect a 100-nF capacitor between SW pin and BOOT. An internal diode connects to VCC and allows BOOT to charge while SW node is low.

NC	5	This pin has no internal connection to the regulator.
AGND	6	Analog ground for internal circuitry. Feedback are measured with respect to this pin. Must connect AGND to both PGND1 and PGND2 on PCB.
FB	7	Output voltage feedback input to the internal control loop. Connect to feedback divider tap point for adjustable output voltage. Do not float or connect to ground.
PG	8	Open-drain power-good status output. Pull this pin up to a suitable voltage supply through a current limiting resistor. High = power OK, low = fault. PG output goes low when EN =low, VIN > 1V.
EN	9	Enable pin to regulator with internal pull-up current source. Pull below 1.1V to disable the converter. Float or connect to VIN to enable the converter. The tap of resistor divider from VIN to GND connecting EN pin can adjust the input voltage lockout threshold.
SW	12	Switching node of the buck converter.

## RECOMMENDED OPERATING CONDITIONS

Over operating free-air temperature range unless otherwise noted

PARAMETER	DEFINITION	MIN	MAX	UNIT
V <sub>IN</sub>	Input voltage range	3.6	36	V
V <sub>OUT</sub>	Output voltage range	1	16	V
T <sub>J</sub>	Operating junction temperature	-40	150	°C

## ESD RATINGS

PARAMETER	DEFINITION	MIN	MAX	UNIT
V <sub>ESD</sub>	Human Body Model(HBM)	-2	+2	kV
	Charged Device Model(CDM)	-1	+1	kV

## THERMAL INFORMATION

PARAMETER	THERMAL METRIC	QFN-12L	UNIT
R <sub>θJA</sub>	Junction to ambient thermal resistance <sup>(1)</sup>	63.02	°C/W
Ψ <sub>JT</sub>	Junction-to-top characterization parameter	3.33	
Ψ <sub>JB</sub>	Junction-to-board characterization parameter <sup>(1)</sup>	7.74	
R <sub>θJctop</sub>	Junction to case thermal resistance <sup>(1)</sup>	63.93	
R <sub>θJB</sub>	Junction-to-board thermal resistance <sup>(1)</sup>	7.95	

(1) SCT provides R<sub>θJA</sub> and R<sub>θJC</sub> numbers only as reference to estimate junction temperatures of the devices. R<sub>θJA</sub> and R<sub>θJC</sub> are not a characteristic of package itself, but of many other system level characteristics such as the design and layout of the printed circuit board (PCB) on which the SCT2434AQ is mounted, thermal pad size, and external environmental factors. The PCB board is a heat sink that is soldered to the leads and thermal pad of the SCT2434AQ. Changing the design or configuration of the PCB board changes the efficiency of the heat sink and therefore the actual R<sub>θJA</sub> and R<sub>θJC</sub>.

# SCT2434AQ

## ELECTRICAL CHARACTERISTICS

V<sub>IN</sub>=24V, T<sub>J</sub>=-40°C~125°C, typical value is tested under 25°C.

SYMBOL	PARAMETER	TEST CONDITION	MIN	TYP	MAX	UNIT
<b>Power Supply</b>						
V <sub>IN</sub>	Operating input voltage		3.6		36	V
V <sub>IN_UVLO</sub>	Input UVLO Threshold	V <sub>IN</sub> rising		3.4	3.6	V
	Hysteresis			300		mV
I <sub>SHDN</sub>	Shutdown current from VIN pin	EN=0		1.2	10	μA
I <sub>Q</sub>	Quiescent current from VIN pin	EN floating, non-switching, BOOT-SW=5V		25	38	μA

### Power MOSFETs

R <sub>DSON_H</sub>	High-side MOSFET on-resistance	V <sub>BOOT</sub> -V <sub>SW</sub> =4.2V		60	100	mΩ
R <sub>DSON_L</sub>	Low-side MOSFET on-resistance			36	65	mΩ

### Reference

V <sub>REF</sub>	Reference voltage of FB	T <sub>J</sub> =25°C	0.99	1	1.01	V
		T <sub>J</sub> =-40°C~125°C	0.985		1.015	V

### Current Limit and Over Current Protection

I <sub>LIM_HS</sub>	High-side power MOSFET peak current limit threshold	T <sub>J</sub> =25°C	4.3	5	5.7	A
		T <sub>J</sub> =-40°C~125°C	4.05		6	A
I <sub>LIM_LSSRC</sub>	Low-side power MOSFET sourcing current limit threshold	T <sub>J</sub> =25°C	3.85	4.5	5.15	A
		T <sub>J</sub> =-40°C~125°C	3.525		5.4	A

### Enable and Soft Startup

V <sub>EN_H</sub>	Enable high threshold		1.17	1.24	1.31	V
V <sub>EN_L</sub>	Enable low threshold		1.05	1.12	1.19	V
I <sub>EN_L</sub>	Enable pin pull-up current	EN=1V		1		μA
I <sub>EN_H</sub>	Enable pin pull-up current	EN=1.5V		4.8		uA
T <sub>SS</sub>	Internal soft start time			4		ms

### Switching Frequency and External Clock Synchronization

F <sub>SW</sub>	Switching frequency	T <sub>J</sub> =25°C	360	400	440	kHz
		T <sub>J</sub> =-40°C~125°C	320		480	kHz
F <sub>JITTER</sub>	Frequency spread spectrum in percentage of F <sub>sw</sub>			±6		%
t <sub>ON_MIN</sub>	Minimum on-time	V <sub>IN</sub> =36V		60		ns

### Power Good

V <sub>PG_UV</sub>	Power-good flag under voltage tripping threshold	POWER GOOD (% of FB voltage)		95		%
		POWER BAD (% of FB voltage)		90		%
V <sub>PG_OV</sub>	Power-good flag over voltage tripping threshold	POWER BAD (% of FB voltage)		110		%
		POWER GOOD (% of FB voltage)		105		%
I <sub>PG</sub>	PWRGD leakage current at high level output	V <sub>Pull-Up</sub> = 5V			200	nA
V <sub>PG_LOW</sub>	PWRGD low level output voltage	I <sub>Pull-Up</sub> = 1 mA		50		mV
t <sub>PGDFLT(rise)</sub>	Delay time to PGOOD high signal			2		ms

SYMBOL	PARAMETER	TEST CONDITION	MIN	TYP	MAX	UNIT
t <sub>PGDFLT(fall)</sub>	Glitch filter time constant for PGOOD function			130		us
<b>Protection</b>						
V <sub>OVP</sub>	Feedback overvoltage with respect to reference voltage	V <sub>FB</sub> /V <sub>REF</sub> rising		110		%
		V <sub>FB</sub> /V <sub>REF</sub> falling		105		%
V <sub>BOOTUV</sub>		BOOT-SW falling		2.7		V
		Hysteresis		400		mV
T <sub>SD</sub>	Thermal shutdown threshold*	T <sub>J</sub> rising		160		°C
		Hysteresis		20		°C

\*Derived from bench characterization

## TYPICAL CHARACTERISTICS

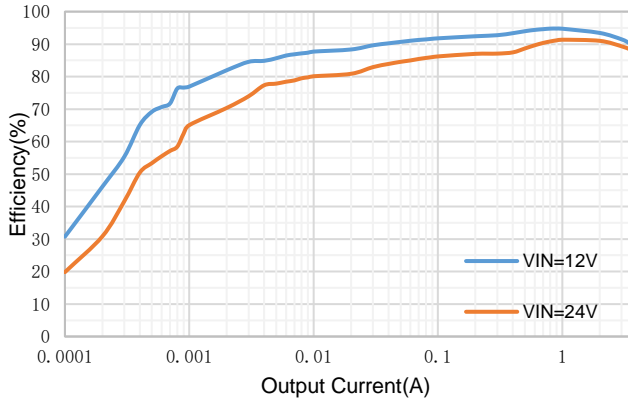

Figure 2. Efficiency,  $F_{sw}=400KHz$ ,  $V_{out}=3.3V$

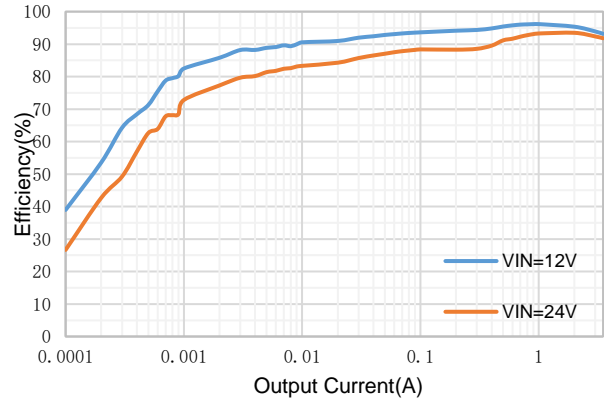

Figure 3. Efficiency,  $F_{sw}=400KHz$ ,  $V_{out}=5V$

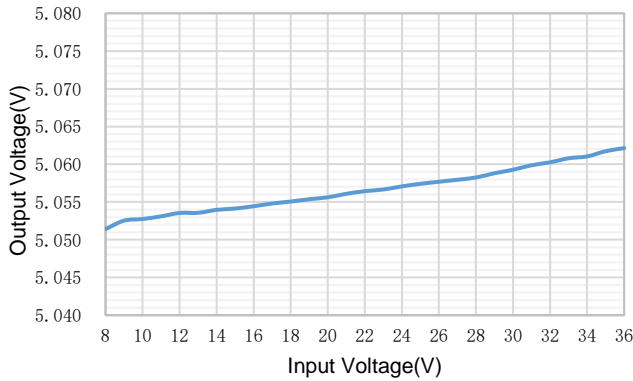

Figure 4. Line Regulation ( $V_{out}=5V$ ,  $I_{load}=3.5A$ )

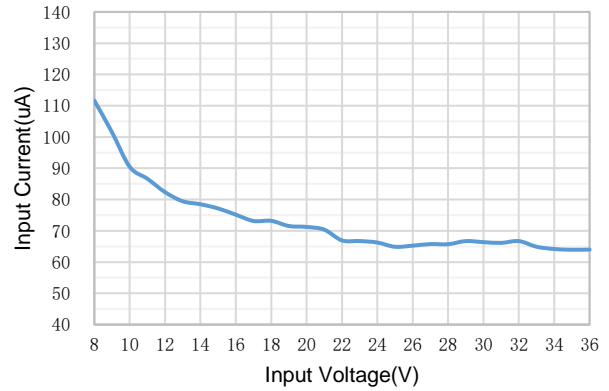

Figure 5. Input Current ( $V_{out}=5V$ ,  $I_{load}=0A$ )

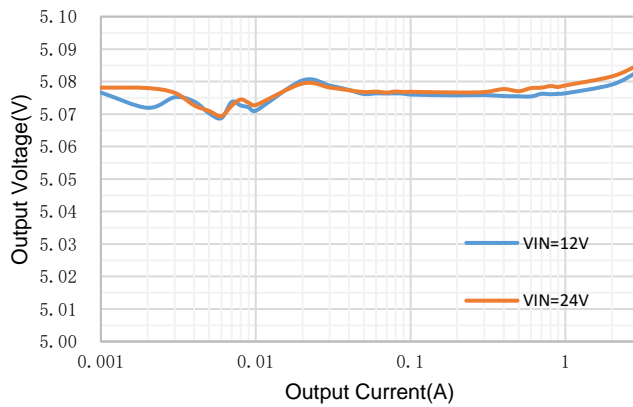

Figure 6. Load Regulation ( $V_{out}=5V$ )

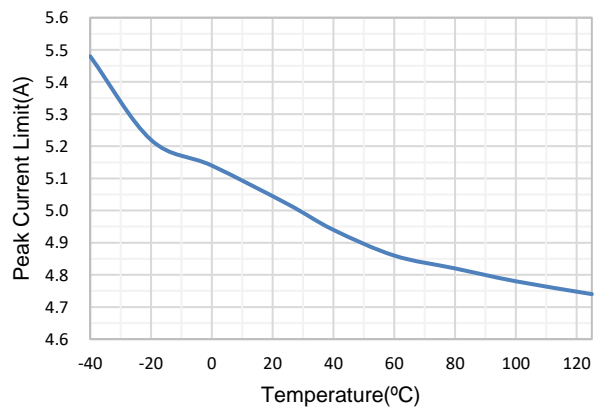

Figure 7. Current Limit vs Temperature

FUNCTIONAL BLOCK DIAGRAM

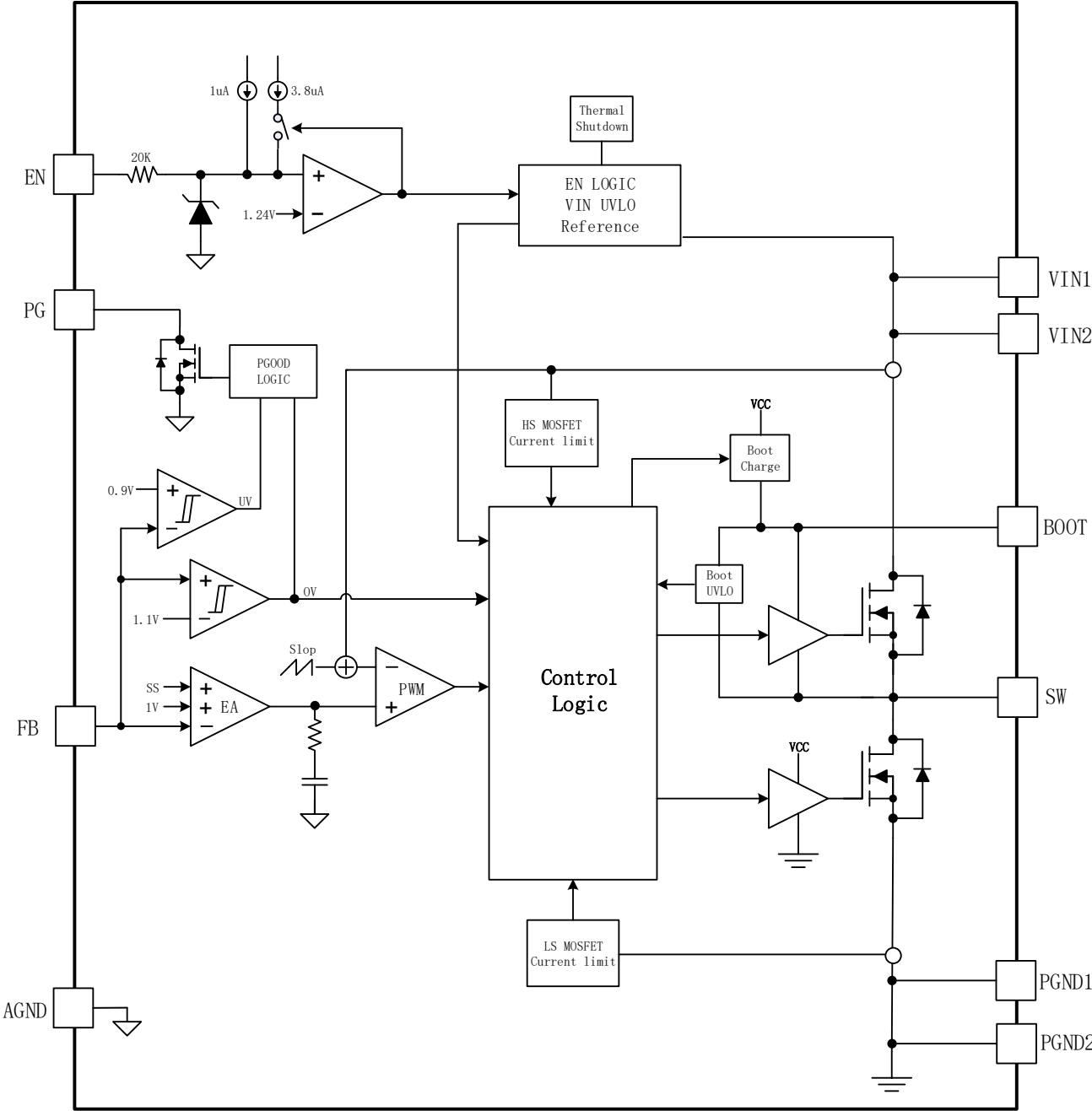

Figure 8. Functional Block Diagram

## OPERATION

### Overview

The SCT2434AQ is a 3.6V-36V input, 3.5A output, EMI friendly synchronous buck converter with built-in 60mΩ R<sub>ds(on)</sub> high-side and 36mΩ R<sub>ds(on)</sub> low-side power MOSFETs. It implements constant frequency peak current mode control to regulate output voltage, providing excellent line and load transient response and simplifying the external frequency compensation design.

The switching frequency is fixed 400kHz. The SCT2434AQ features an internal 4ms soft-start time to avoid large inrush current and output voltage overshoot during startup. The device also supports monolithic startup with pre-biased output condition. The seamless mode-transition between PWM mode and PSM mode operations ensure high efficiency over wide load current range. The quiescent current is typically 25uA under no load or sleep mode condition to achieve high efficiency at light load.

The EN pin is a high-voltage pin with a precision threshold that can be used to adjust the input voltage lockout thresholds with two external resistors to meet accurate higher UVLO system requirements. Floating EN pin enables the device with the internal pull-up current to the pin. Connecting EN pin to VIN directly starts up the device automatically.

The SCT2434AQ implements the Frequency Spread Spectrum FSS modulation spreading of ±6% centered selected switching frequency. FSS improves EMI performance by not allowing emitted energy to stay in any one receiver band for a significant length of time.

The SCT2434AQ full protection features include the input under-voltage lockout, the output over-voltage protection, over current protection with cycle-by-cycle current limiting and hiccup mode, output hard short protection and thermal shutdown protection.

### Peak Current Mode Control

The SCT2434AQ employs fixed frequency peak current mode control. An internal clock initiates turning on the integrated high-side power MOSFET Q1 in each cycle, then inductor current rises linearly. When the current through high-side MOSFET reaches the threshold level set by the COMP voltage of the internal error amplifier, the high-side MOSFET turns off. The synchronous low-side MOSFET Q2 turns on till the next clock cycle begins or the inductor current falls to zero.

The error amplifier serves the COMP node by comparing the voltage of the FB pin with an internal 1.0V reference voltage. When the load current increases, a reduction in the feedback voltage relative to the reference raises COMP voltage till the average inductor current matches the increased load current. This feedback loop well regulates the output voltage to the reference. The device also integrates an internal slope compensation circuitry to prevent sub-harmonic oscillation when duty cycle is greater than 50% for a fixed frequency peak current mode control.

The SCT2434AQ operates in Pulse Skipping Mode (PSM) with light load current to improve efficiency. When the load current decreases, an increment in the feedback voltage leads COMP voltage drop. When COMP falls to a low clamp threshold (400mV typically), device enters PSM. The output voltage decays due to output capacitor discharging during skipping period. Once FB voltage drops lower than the reference voltage, and the COMP voltage rises above low clamp threshold. Then high-side power MOSFET turns on in next clock pulse. After several switching cycles with typical 0.8A peak inductor current, COMP voltage drops and is clamped again and pulse skipping mode repeats if the output continues light loaded.

This control scheme helps achieving higher efficiency by skipping cycles to reduce switching power loss and gate drive charging loss. The controller consumption quiescent current is 25uA during skipping period with no switching to improve efficiency further.



## Enable and Under Voltage Lockout Threshold

The SCT2434AQ is enabled when the VIN pin voltage rises about 3.4V and the EN pin voltage exceeds the enable threshold of 1.24V. The device is disabled when the VIN pin voltage falls below 3.1V or when the EN pin voltage is below 1.12V. An internal 1uA pull up current source to EN pin allows the device enable when EN pin floats.

EN pin is a high voltage pin that can be connected to VIN directly to start up the device.

For a higher system UVLO threshold, connect an external resistor divider (R1 and R2) shown in Figure 9 from VIN to EN. The UVLO rising and falling threshold can be calculated by Equation 1 and Equation 2 respectively.

$$R1 = \frac{V_{rise} \left( \frac{V_{ENF}}{V_{ENR}} \right) - V_{fall}}{I_1 \left( 1 - \frac{V_{ENF}}{V_{ENR}} \right) + I_2} \quad (1)$$

$$R2 = \frac{R_1 \times V_{ENF}}{V_{fall} - V_{ENF} + R_1(I_1 + I_2)} \quad (2)$$

where

- $V_{rise}$  is rising threshold of Vin UVLO
- $V_{fall}$  is falling threshold of Vin UVLO
- $I_1=1\mu A$ ,  $I_2=3.8\mu A$ ,  $V_{ENR}=1.24V$ ,  $V_{ENF}=1.12V$

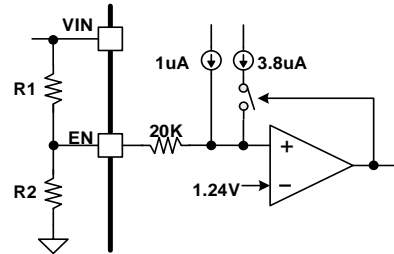

Figure 9. System UVLO by enable divide

## Output Voltage

The SCT2434AQ regulates the internal reference voltage at 1.0V with  $\pm 1\%$  tolerance over the operating temperature and voltage range. The output voltage is set by a resistor divider from the output node to the FB pin. It is recommended to use 1% tolerance or better resistors. Use Equation 3 to calculate resistance of resistor dividers. To improve efficiency at light loads, larger value resistors are recommended. However, if the values are too high, the regulator will be more susceptible to noise affecting output voltage accuracy.

$$R_{FB\_TOP} = \left( \frac{V_{OUT}}{V_{REF}} - 1 \right) * R_{FB\_BOT} \quad (3)$$

where

- $R_{FB\_TOP}$  is the resistor connecting the output to the FB pin.
- $R_{FB\_BOT}$  is the resistor connecting the FB pin to the ground.

## Internal Soft-Start

The SCT2434AQ integrates an internal soft-start circuit that ramps the reference voltage from zero volts to 1.0V reference voltage in 4mS. If the EN pin is pulled below 1.12V, switching stops and the internal soft-start resets. The soft-start also resets during shutdown due to thermal overloading.

## Frequency Spread Spectrum

To reduce EMI, the SCT2434AQ implements Frequency Spread Spectrum (FSS). The FSS circuitry shifts the switching frequency of the regulator periodically within a certain frequency range around the adjusted switching frequency. The jittering span is  $\pm 6\%$  of the switching frequency with 1/512 swing frequency.

# SCT2434AQ

## Bootstrap Voltage Regulator and Low Drop-out Operation

An external bootstrap capacitor between BOOT pin and SW pin powers the floating gate driver to high-side power MOSFET. The bootstrap capacitor voltage is charged from an integrated voltage regulator when high-side power MOSFET is off and low-side power MOSFET is on.

The UVLO of high-side MOSFET gate driver has rising threshold of 3.1V and hysteresis of 400mV. When the device operates with high duty cycle or extremely light load, bootstrap capacitor may be not recharged in considerable long time. The voltage at bootstrap capacitor is insufficient to drive high-side MOSFET fully on. When the voltage across bootstrap capacitor drops below 2.7V, BOOT UVLO occurs. The converter forces turning on low-side MOSFET periodically to refresh the voltage of bootstrap capacitor to guarantee the converter's operation over a wide duty range.

During the condition of ultra-low voltage difference from the input to the output, SCT2434AQ operates in Low Drop-Out LDO mode. High-side MOSFET remains turning on as long as the BOOT pin to SW pin voltage is higher than BOOT UVLO threshold 3.1V. When the voltage from BOOT to SW drops below 2.7V, the high-side MOSFET turns off and low-side MOSFET turns on to recharge bootstrap capacitor periodically in the following several switching cycles. Low-side MOSFET only turns on for 100ns in each refresh cycle to minimize the output voltage ripple. Low-side MOSFET may turn on for several times till the bootstrap voltage is charged to higher than 3.1V for high-side MOSFET working normally. The effective duty cycle of the converter during LDO operation can be approaching to 100%

During slowing power up and power down application, the output voltage can closely track the input voltage ramping down thanks to LDO operation mode. As the input voltage is reduced to near the output voltage, i.e. during slowing power-up and power-down application, the off-time of the high side MOSFET starts to approach the minimum value. Without LDO operation mode, beyond this point the switching may become erratic and/or the output voltage will fall out of regulation. To avoid this problem, the SCT2434AQ LDO mode automatically reduces the switching frequency to increase the effective duty cycle and maintain regulation.

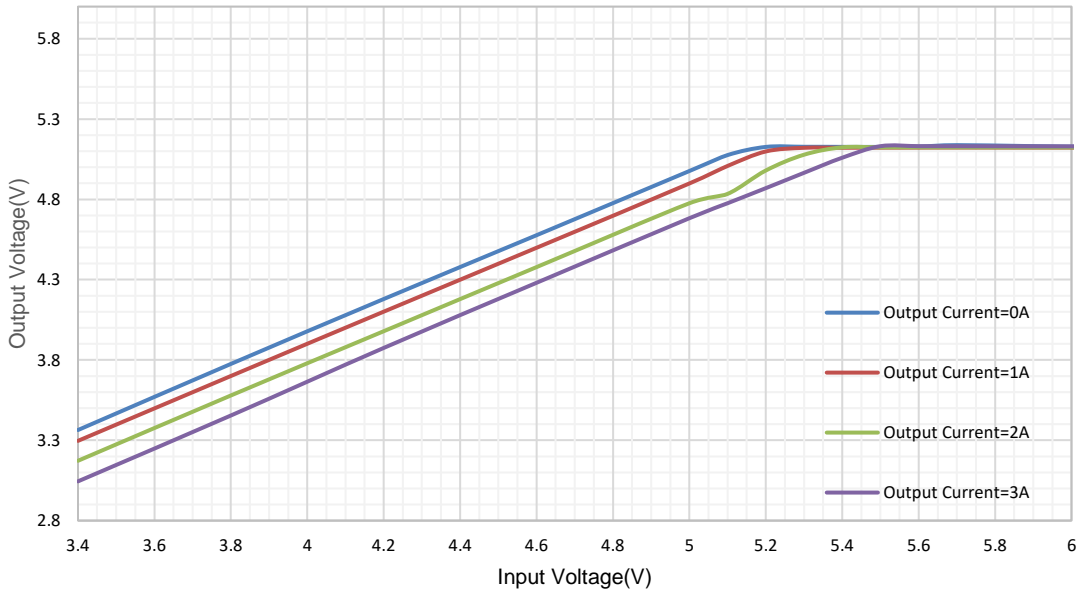

Figure 10. LDO Operation Characteristic ( $V_{OUT}=5V$ )

## Over Current Limit and Hiccup Mode

The inductor current is monitored during high-side MOSFET Q1 and low-side MOSFET Q2 on. The SCT2434AQ implements over current protection with cycle-by-cycle limiting high-side MOSFET peak current and low-side MOSFET valley current to avoid inductor current running away during unexpected overload or output hard short condition.

When overload or hard short happens, the converter cannot provide output current to satisfy loading requirement. The inductor current is clamped at over current limitation. Thus, the output voltage drops below regulated voltage with FB voltage less than internal reference voltage continuously. The internal COMP voltage ramps up to high clamp voltage 1.7V typical. When COMP voltage is clamped for 16 cycles of low side OC, the converter stops switching. After remaining OFF for 33.6ms, the device restarts from soft starting phase. If overload or hard short condition still exists during soft-start and make COMP voltage clamped at high, after soft start time and COMP still keep high for 16 cycles of low side OC, the device enters into turning-off mode again. When overload or hard short condition is removed, the device automatically recovers to enters normal regulating operation.

The hiccup protection mode above makes the average short circuit current to alleviate thermal issues and protect the regulator.

## Over voltage Protection

The SCT2434AQ implements the Over-Voltage Protection OVP circuitry to minimize output voltage overshoot during load transient, recovering from output fault condition or light load transient. The overvoltage comparator in OVP circuit compares the FB pin voltage to the internal reference voltage. When FB voltage exceeds 110% of internal 1.0V reference voltage, the high-side MOSFET turns off to avoid output voltage continue to increase. When the FB pin voltage falls below 105% of the 1.0V reference voltage, the high-side MOSFET can turn on again.

## Power Good

The PG pin is an open-drain output. A pull up resistor between the values of 10K $\Omega$  and 100K $\Omega$  to a voltage source that is 5V or less is recommended.

Once the FB pin is between 95% and 105% of the internal voltage reference the PG pin is de-asserted and the pin floats with 2ms delay. The PG pin is pulled low when the FB is lower than 90% or greater than 110% of the nominal internal reference voltage with 130us deglitching time. Also, the PG is pulled low if Vin UVLO or thermal shutdown are asserted or the EN pin pulled low, Output voltage excursions that are shorter than 130us deglitching time do not trip the PG flag.

## Thermal Shutdown

The SCT2434AQ protects the device from the damage during excessive heat and power dissipation conditions. Once the junction temperature exceeds 160°C, the internal thermal sensor stops power MOSFETs switching. When the junction temperature falls below 140°C, the device restarts with internal soft start phase.

## APPLICATION INFORMATION

### Typical Application

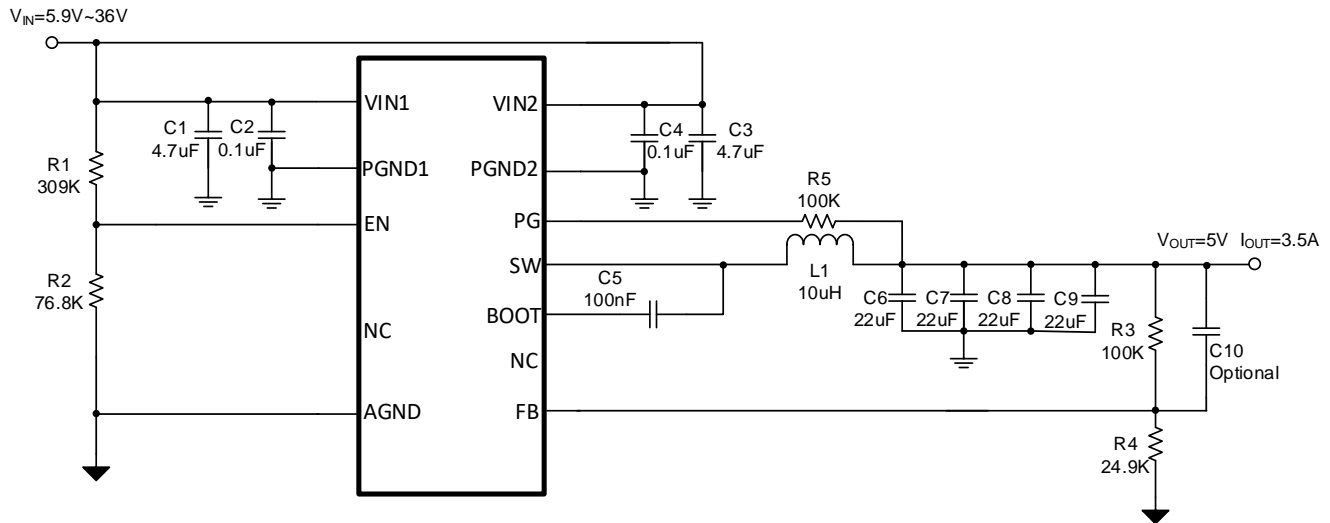

Figure 11. SCT2434AQ Design Example, 5V Output with Adjustable UVLO

#### Design Parameters

Design Parameters	Example Value
Input Voltage	12V Normal 5.9V to 36V
Output Voltage	5V
Maximum Output Current	3.5A
Switching Frequency	400KHz
Output voltage ripple (peak to peak)	7mV
Transient Response 0.75A to 2.25A load step	$\Delta V_{out} = 315\text{mV}$
Start Input Voltage (rising VIN)	5.9V
Stop Input Voltage (falling VIN)	4.1V

## Output Voltage

The output voltage is set by an external resistor divider  $R_3$  and  $R_4$  in typical application schematic. When the output voltage is greater than 3V, recommended  $R_4$  resistance is 24.9K $\Omega$ . Use equation 4 to calculate  $R_3$ .

$$R_3 = \left( \frac{V_{OUT}}{V_{REF}} - 1 \right) * R_4 \quad (4)$$

where:

- $V_{REF}$  is the feedback reference voltage, typical 1V

If the output voltage is less than 3V,  $R_4$  cannot exceed 24 K $\Omega$ .

**Table 1.  $R_3$ ,  $R_4$  Value for Common Output Voltage (Room Temperature)**

V <sub>OUT</sub>	R <sub>3</sub>	R <sub>4</sub>
3.3 V	57.6 K $\Omega$	24.9 K $\Omega$
5 V	100 K $\Omega$	24.9 K $\Omega$
12 V	274 K $\Omega$	24.9 K $\Omega$

## Under Voltage Lock-Out

An external voltage divider network of  $R_1$  from the input to EN pin and  $R_2$  from EN pin to the ground can set the input voltage's Under Voltage Lock-Out (UVLO) threshold. The UVLO has two thresholds, one for power up when the input voltage is rising and the other for power down or brown outs when the input voltage is falling. For the example design, the supply should turn on and start switching once the input voltage increases above 5.9V (start or enable). After the regulator starts switching, it should continue to do so until the input voltage falls below 4.1V (stop or disable). Use Equation 5 and Equation 6 to calculate the values 309 k $\Omega$  and 76.8 k $\Omega$  of  $R_1$  and  $R_2$  resistors.

$$R_1 = \frac{V_{rise} \left( \frac{V_{ENF}}{V_{ENR}} \right) - V_{fall}}{I_1 \left( 1 - \frac{V_{ENF}}{V_{ENR}} \right) + I_2} \quad (5)$$

$$R_2 = \frac{R_1 \times V_{ENF}}{V_{fall} - V_{ENF} + R_1(I_1 + I_2)} \quad (6)$$

where:

- $V_{rise}$  is rising threshold of  $V_{in}$  UVLO
- $V_{fall}$  is falling threshold of  $V_{in}$  UVLO
- $I_1=1\mu A$ ,  $I_2=3.8\mu A$ ,  $V_{ENR}=1.24V$ ,  $V_{ENF}=1.12V$

## Inductor Selection

There are several factors should be considered in selecting inductor such as inductance, saturation current, the RMS current and DC resistance(DCR). Larger inductance results in less inductor current ripple and therefore leads to lower output voltage ripple. However, the larger value inductor always corresponds to a bigger physical size, higher series resistance, and lower saturation current. A good rule for determining the inductance to use is to allow the inductor peak-to-peak ripple current to be approximately 20%~40% of the maximum output current.

The peak-to-peak ripple current in the inductor  $I_{LPP}$  can be calculated as in Equation 7.

$$I_{LPP} = \frac{V_{OUT} * (V_{IN} - V_{OUT})}{V_{IN} * L * f_{SW}} \quad (7)$$

Where

- $I_{LPP}$  is the inductor peak-to-peak current
- $L$  is the inductance of inductor

# SCT2434AQ

---

- $f_{sw}$  is the switching frequency
- $V_{OUT}$  is the output voltage
- $V_{IN}$  is the input voltage

Since the inductor-current ripple increases with the input voltage, so the maximum input voltage in application is always used to calculate the minimum inductance required. Use Equation 8 to calculate the inductance value.

$$L_{MIN} = \frac{V_{OUT}}{f_{SW} * LIR * I_{OUT(max)}} * \left(1 - \frac{V_{OUT}}{V_{IN(max)}}\right) \quad (8)$$

Where

- $L_{MIN}$  is the minimum inductance required
- $f_{sw}$  is the switching frequency
- $V_{OUT}$  is the output voltage
- $V_{IN(max)}$  is the maximum input voltage
- $I_{OUT(max)}$  is the maximum DC load current
- LIR is coefficient of  $I_{LPP}$  to  $I_{OUT}$

The total current flowing through the inductor is the inductor ripple current plus the output current. When selecting an inductor, choose its rated current especially the saturation current larger than its peak operation current and RMS current also not be exceeded. Therefore, the peak switching current of inductor,  $I_{LPEAK}$  and  $I_{LRMS}$  can be calculated as in equation 9 and equation 10.

$$I_{LPEAK} = I_{OUT} + \frac{I_{LPP}}{2} \quad (9)$$

$$I_{LRMS} = \sqrt{(I_{OUT})^2 + \frac{1}{12} * (I_{LPP})^2} \quad (10)$$

Where

- $I_{LPEAK}$  is the inductor peak current
- $I_{OUT}$  is the DC load current
- $I_{LPP}$  is the inductor peak-to-peak current
- $I_{LRMS}$  is the inductor RMS current

In overloading or load transient conditions, the inductor peak current can increase up to the switch current limit of the device which is typically 5A. The most conservative approach is to choose an inductor with a saturation current rating greater than 5A. Because of the maximum  $I_{LPEAK}$  limited by device, the maximum output current that the SCT2434AQ can deliver also depends on the inductor current ripple. Thus, the maximum desired output current also affects the selection of inductance. The smaller inductor results in larger inductor current ripple leading to a higher maximum output current.

For this design, use LIR=0.3 to 0.5, and the inductor value is calculated to be 7.8uH, the RMS inductor current is 3.5A and the peak inductor current is 4.2A. The chosen inductor is a WE 74439358100, which has a saturation current rating of 6.3A. This also has a typical inductance of 10μH at no load and 9.49 μH at 3.5A load. The inductor DCR is 19mΩ.

## Input Capacitor Selection

The input current to the step-down DCDC converter is discontinuous, therefore it requires a capacitor to supply the AC current to the step-down DCDC converter while maintaining the DC input voltage. Use capacitors with low ESR for better performance. Ceramic capacitors with X5R or X7R dielectrics are usually suggested because of their low ESR and small temperature coefficients, and it is strongly recommended to use another lower value capacitor (e.g. 0.1uF) with small package size (0603) to filter high frequency switching noise. Place the small size capacitor as close to  $V_{IN}$  and GND pins as possible.

The voltage rating of the input capacitor must be greater than the maximum input voltage. And the capacitor must also have a ripple current rating greater than the maximum input current ripple. The RMS current in the input capacitor can be calculated using Equation 11.

$$I_{CINRMS} = I_{OUT} * \sqrt{\frac{V_{OUT}}{V_{IN}} * (1 - \frac{V_{OUT}}{V_{IN}})} \quad (11)$$

The worst case condition occurs at  $V_{IN}=2*V_{OUT}$ , where:

$$I_{CINRMS} = 0.5 * I_{OUT} \quad (12)$$

For simplification, choose an input capacitor with an RMS current rating greater than half of the maximum load current.

When selecting ceramic capacitors, it needs to consider the effective value of a capacitor decreasing as the DC bias voltage across a capacitor increases.

The input capacitance value determines the input ripple voltage of the regulator. The input voltage ripple can be calculated using Equation 13 and the maximum input voltage ripple occurs at 50% duty cycle.

$$\Delta V_{IN} = \frac{I_{OUT}}{f_{SW} * C_{IN}} * \frac{V_{OUT}}{V_{IN}} * (1 - \frac{V_{OUT}}{V_{IN}}) \quad (13)$$

For this example, two 4.7 $\mu$ F, X7R ceramic capacitors rated for 50 V in parallel are used. And a 0.1  $\mu$ F for high-frequency filtering capacitor is placed as close as possible to the device pins.

## Bootstrap Capacitor Selection

A 0.1 $\mu$ F ceramic capacitor must be connected between BOOT pin and SW pin for proper operation. A ceramic capacitor with X5R or better grade dielectric is recommended. The capacitor should have a 10V or higher voltage rating.

## Output Capacitor Selection

The selection of output capacitor will affect output voltage ripple in steady state and load transient performance.

The output ripple is essentially composed of two parts. One is caused by the inductor current ripple going through the Equivalent Series Resistance ESR of the output capacitors and the other is caused by the inductor current ripple charging and discharging the output capacitors. To achieve small output voltage ripple, choose a low-ESR output capacitor like ceramic capacitor. For ceramic capacitors, the capacitance dominates the output ripple. For simplification, the output voltage ripple can be estimated by Equation 14 desired.

$$\Delta V_{OUT} = \frac{V_{OUT} * (V_{IN} - V_{OUT})}{8 * f_{SW}^2 * L * C_{OUT} * V_{IN}} \quad (14)$$

Where

- $\Delta V_{OUT}$  is the output voltage ripple
- $f_{SW}$  is the switching frequency
- L is the inductance of inductor
- $C_{OUT}$  is the output capacitance
- $V_{OUT}$  is the output voltage
- $V_{IN}$  is the input voltage

Due to capacitor's degrading under DC bias, the bias voltage can significantly reduce capacitance. Ceramic capacitors can lose most of their capacitance at rated voltage. Therefore, leave margin on the voltage rating to ensure adequate effective capacitance. Typically, two 47 $\mu$ F ceramic output capacitors work for most applications.

**Table 2: Typical External Component Values**

V <sub>OUT</sub>	R <sub>3</sub>	R <sub>4</sub>	FREQUENCY	L <sub>1</sub>	C <sub>OUT</sub>
3.3V	57.6 KΩ	24.9 KΩ	400KHz	10uH	4*22uF
5V	100 KΩ	24.9 KΩ	400KHz	10uH	4*22uF
12V	274 KΩ	24.9 KΩ	400KHz	22uH	4*22uF



## Application Waveforms

$V_{IN}=12V$ ,  $V_{OUT}=5V$ , unless otherwise noted

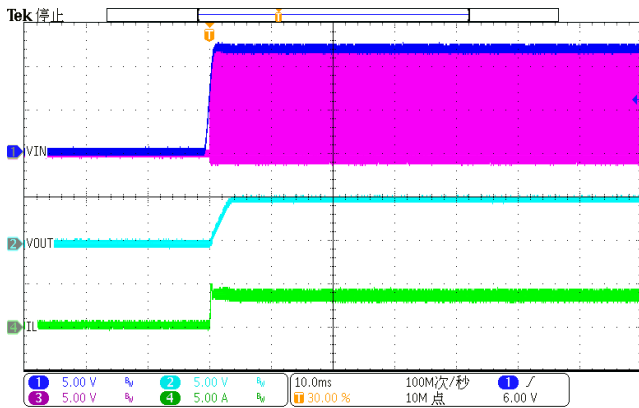

Figure 12. Power up( $I_{LOAD}=3.5A$ )

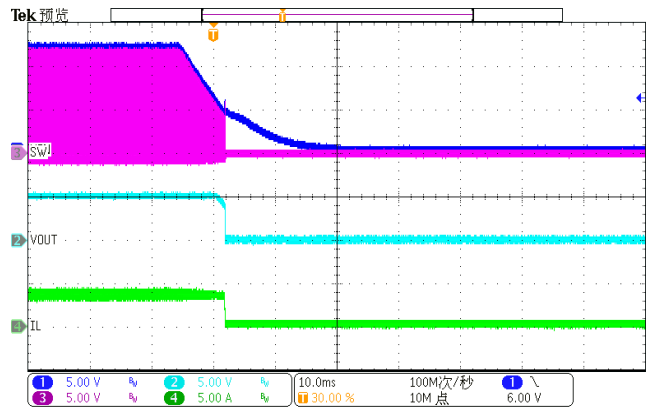

Figure 13. Power down( $I_{LOAD}=3.5A$ )

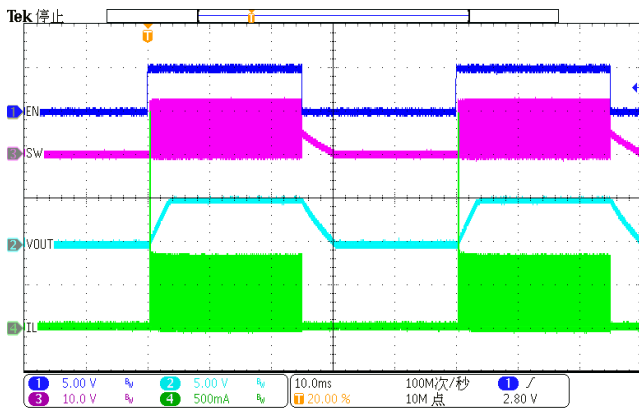

Figure 14. EN toggle ( $I_{LOAD}=0.1A$ )

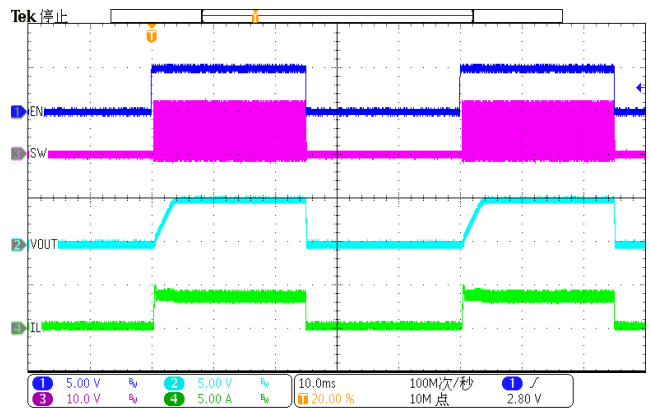

Figure 15. EN toggle ( $I_{LOAD}=3.5A$ )

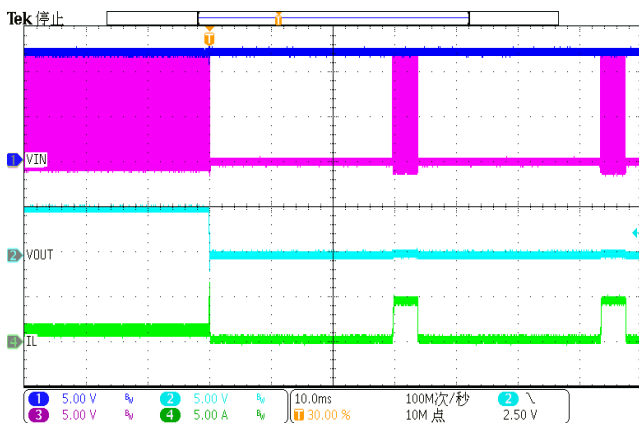

Figure 16. Over Current Protection( $1A$  to hard short)

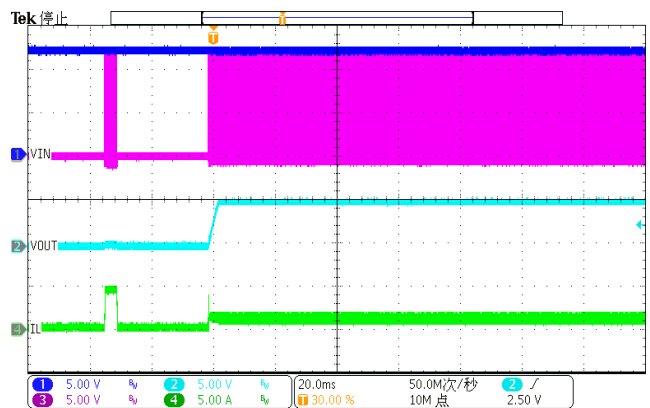

Figure 17. Over Current Release (hard short to  $1A$ )

## Application Waveforms

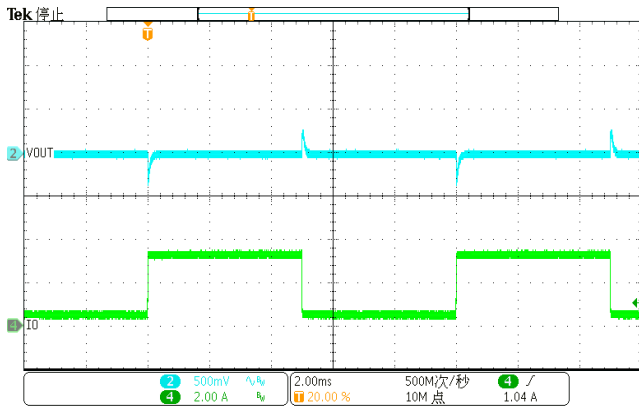

Figure 18. Load Transient (0.35A-3.15A, 1.6A/us)

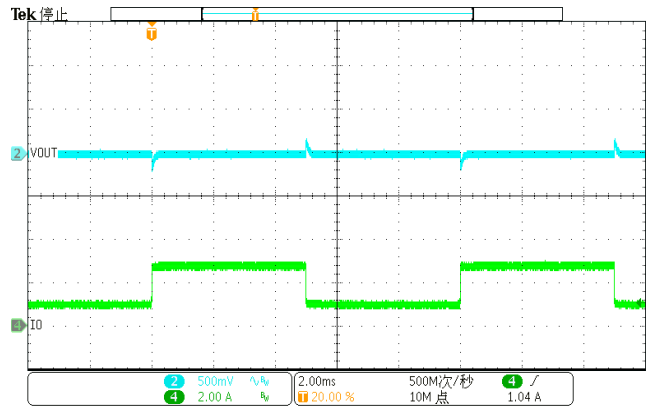

Figure 19. Load Transient (0.87A-2.63A, 1.6A/us)

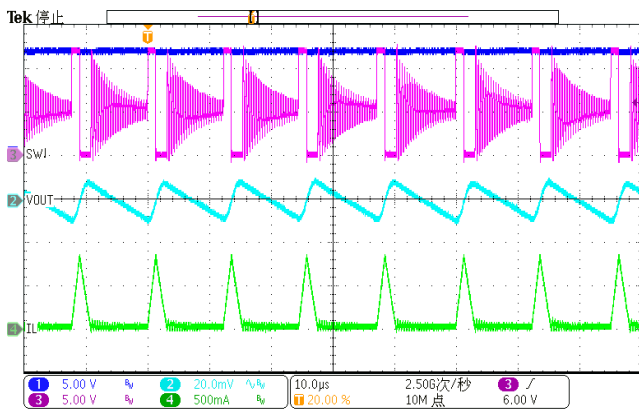

Figure 20. Output Ripple (I<sub>LOAD</sub>=100mA)

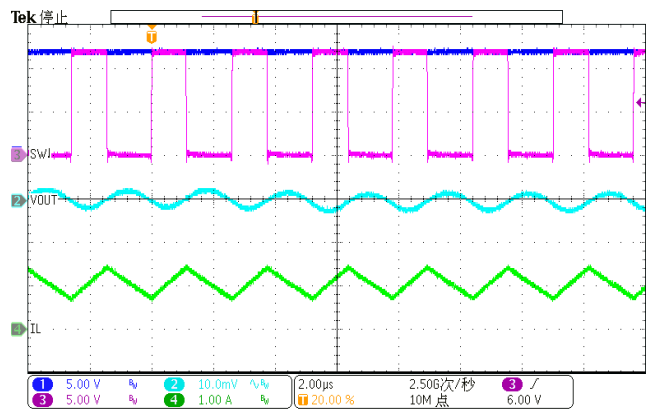

Figure 21. Output Ripple (I<sub>LOAD</sub>=1A)

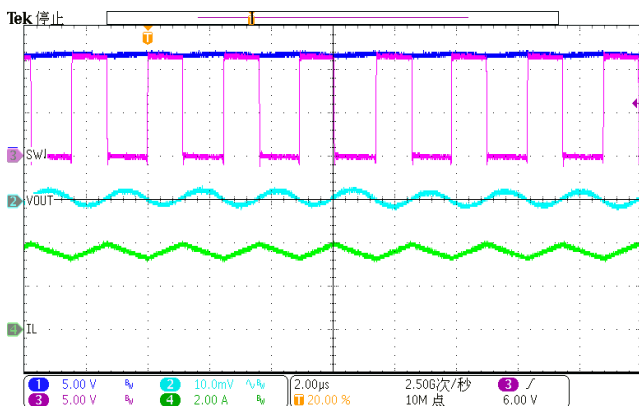

Figure 22. Output Ripple (I<sub>LOAD</sub>=3.5A)

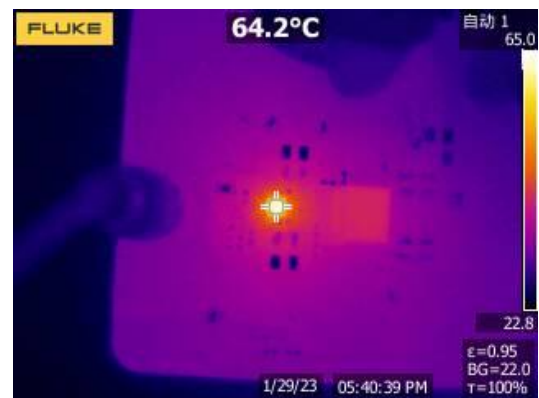

Figure 23. Thermal, 12V<sub>IN</sub>, 5V<sub>OUT</sub>, 3.5A

## Layout Guideline

Proper PCB layout is a critical for SCT2434AQ's stable and efficient operation. The traces conducting fast switching currents or voltages are easy to interact with stray inductance and parasitic capacitance to generate noise and degrade performance. For better results, follow these guidelines as below:

1. Power grounding scheme is very critical because of carrying power, thermal, and glitch/bouncing noise associated with clock frequency. The thumb of rule is to make ground trace lowest impedance and power are distributed evenly on PCB. Sufficiently placing ground area will optimize thermal and not causing over heat area.
2. Place a low ESR ceramic capacitor as close to VIN pin and PGND as possible to reduce parasitic effect.
3. Output inductor should be placed close to the SW pin. The area of the PCB conductor minimized to prevent excessive capacitive coupling.
4. UVLO adjust and feedback components should connect to small signal ground which must return to the GND pin without any interleaving with power ground.
5. For achieving better thermal performance, a four-layer layout is strongly recommended.

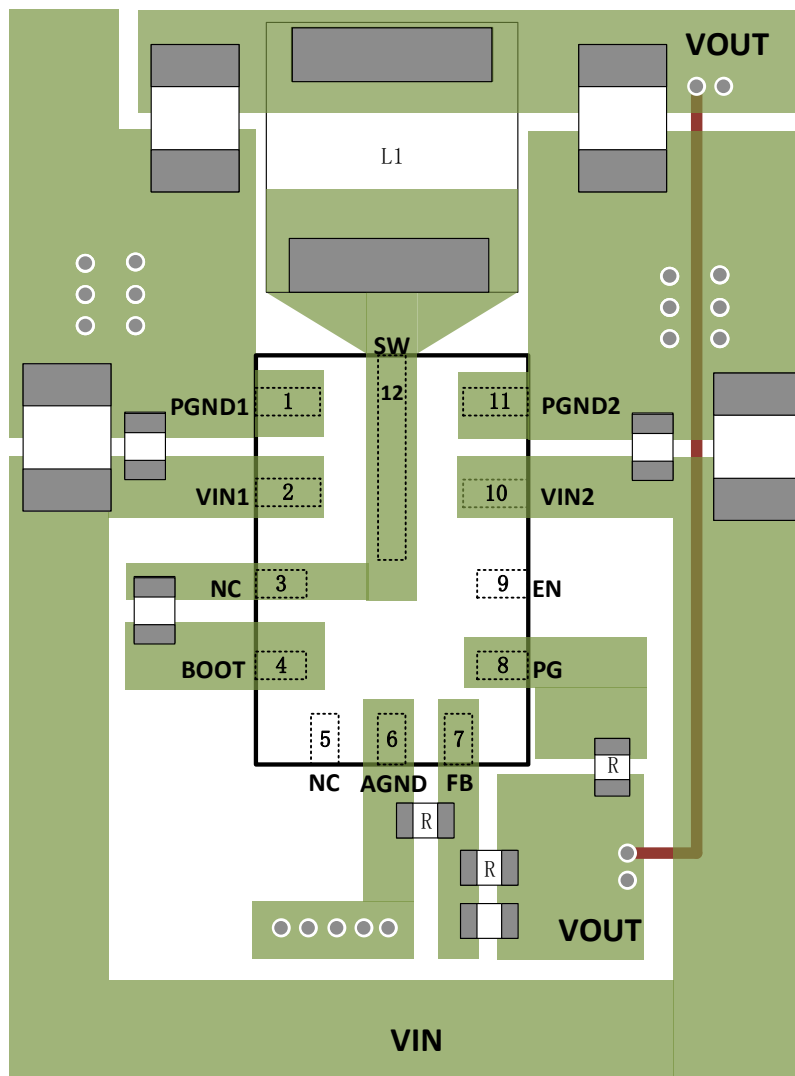
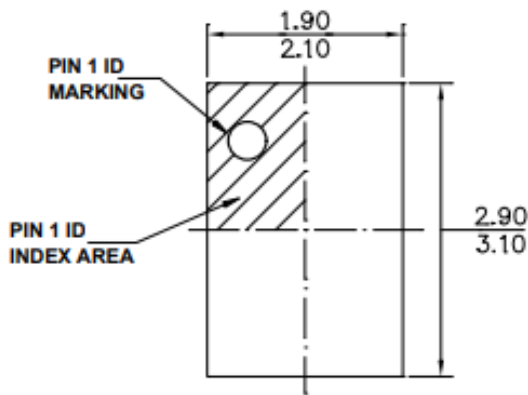
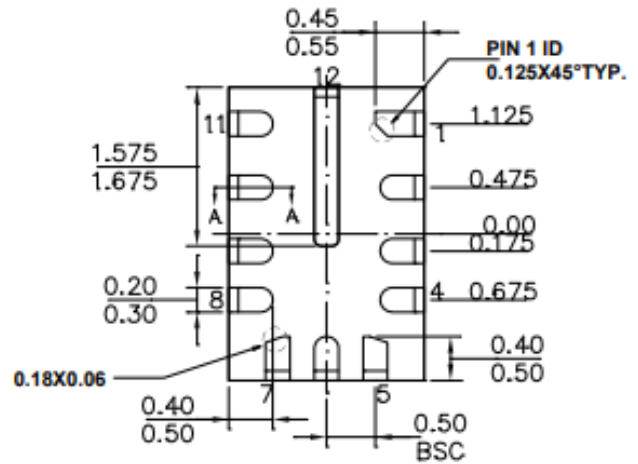

Figure 24. PCB Layout Example

## PACKAGE INFORMATION



**TOP VIEW**



**BOTTOM VIEW**

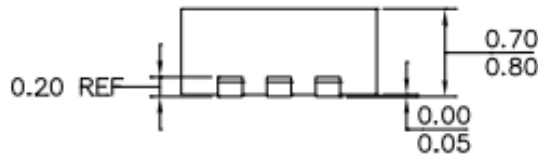

**SIDE VIEW**

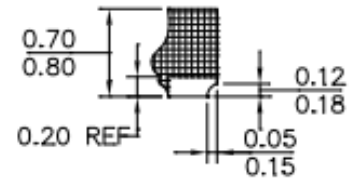

**SECTION A-A**

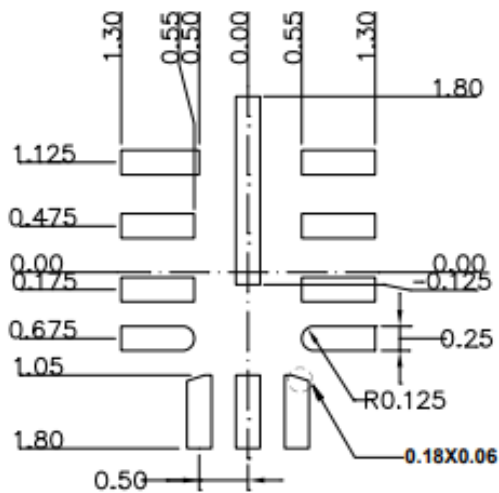

**RECOMMENDED LAND PATTERN**

**NOTE:**

- 1) THE LEAD SIDE IS WETTABLE.
- 2) ALL DIMENSIONS ARE IN MILLIMETERS.
- 3) LEAD COPLANARITY SHALL BE 0.08 MILLIMETERS MAX.
- 4) JEDEC REFERENCE IS MO-220.
- 5) DRAWING IS NOT TO SCALE.

TAPE AND REEL INFORMATION

